

American Water Works Association
ANSI/AWWA C207-01
(Revision of ANSI/AWWA C207-94)



AWWA STANDARD
FOR
**STEEL PIPE FLANGES FOR WATERWORKS
SERVICE—SIZES 4 IN. THROUGH 144 IN.
(100 MM THROUGH 3,600 MM)**

Effective date: April 1, 2002.

First edition approved by AWWA Board of Directors June 17, 1955.

This edition approved June 17, 2001.

Approved by American National Standards Institute Jan. 18, 2002.

AMERICAN WATER WORKS ASSOCIATION

6666 West Quincy Avenue, Denver, Colorado 80235

www.awwa.org

AWWA Standard

This document is an American Water Works Association (AWWA) standard. It is not a specification. AWWA standards describe minimum requirements and do not contain all of the engineering and administrative information normally contained in specifications. The AWWA standards usually contain options that must be evaluated by the user of the standard. Until each optional feature is specified by the user, the product or service is not fully defined. AWWA publication of a standard does not constitute endorsement of any product or product type, nor does AWWA test, certify, or approve any product. The use of AWWA standards is entirely voluntary. AWWA standards are intended to represent a consensus of the water supply industry that the product described will provide satisfactory service. When AWWA revises or withdraws this standard, an official notice of action will be placed on the first page of the classified advertising section of *Journal AWWA*. The action becomes effective on the first day of the month following the month of *Journal AWWA* publication of the official notice.

American National Standard

An American National Standard implies a consensus of those substantially concerned with its scope and provisions. An American National Standard is intended as a guide to aid the manufacturer, the consumer, and the general public. The existence of an American National Standard does not in any respect preclude anyone, whether that person has approved the standard or not, from manufacturing, marketing, purchasing, or using products, processes, or procedures not conforming to the standard. American National Standards are subject to periodic review, and users are cautioned to obtain the latest editions. Producers of goods made in conformity with an American National Standard are encouraged to state on their own responsibility in advertising and promotional materials or on tags or labels that the goods are produced in conformity with particular American National Standards.

CAUTION NOTICE: The American National Standards Institute (ANSI) approval date on the front cover of this standard indicates completion of the ANSI approval process. This American National Standard may be revised or withdrawn at any time. ANSI procedures require that action be taken to reaffirm, revise, or withdraw this standard no later than five years from the date of publication. Purchasers of American National Standards may receive current information on all standards by calling or writing the American National Standards Institute, 25 W. 43rd St., Fourth Floor, New York, NY 10036; (212) 642-4900.

All rights reserved. No part of this publication may be reproduced or transmitted in any form or by any means, electronic or mechanical, including photocopy, recording, or any information or retrieval system, except in the form of brief excerpts or quotations for review purposes, without the written permission of the publisher.

Copyright © 2001 by American Water Works Association
Printed in USA

Committee Personnel

The Steel Water Pipe-Manufacturers Technical Advisory Committee (SWPMTAC) Task Group on C207, which developed this standard, had the following personnel at the time:

Bruce Vanderploeg, *Chair*

H.H. Bardakjian, Ameron Concrete & Steel Pipe, Rancho Cucamonga, Calif.	(AWWA)
Ken Clark, Mueller Company, Decatur, Ill.	(AWWA)
Aaron Collins, JCM Industries, Nash, Texas	(AWWA)
Mike Fite, Pacific Coast Flange, Ukiah, Calif.	(AWWA)
Z.J. Gentile, Ford Meter Box Company Inc., Pell City, Ala.	(AWWA)
B.D. Keil, Continental Pipe Manufacturing Company, Pleasant Grove, Utah	(AWWA)
J.L. Luka, American Spiral-Weld Pipe Company, Columbia, S.C.	(AWWA)
Marvin Mintz, M-Square Associates Inc., Valley Stream, N.Y.	(AWWA)
Steve McMillen, Continental Manufacturing Inc., Nacogdoches, Texas	(AWWA)
R.N. Satyarthi, Baker Coupling Company Inc., Los Angeles, Calif.	(AWWA)
K.L. Shaddix, Smith-Blair Inc., Texarkana, Texas	(AWWA)
Bill Spotts, RTLK Piping Products Inc., Kosse, Texas	(AWWA)
Martin Topps, Glynwed Pipe Systems, Hixson, Tenn.	(AWWA)
M.A. Vanderbosch, CAB Inc., Norcross, Ga.	(AWWA)
Bruce Vanderploeg, Northwest Pipe Company, Portland, Ore.	(AWWA)
D.R. Wagner, Wagner Consultants, St. Louis, Mo.	(AWWA)

The AWWA Standards Committee on Steel Pipe (287), which reviewed and approved this standard, had the following personnel at the time of approval:

George J. Tupac, *Chair*
John H. Bambei Jr., *Vice-Chair*
Dennis Dechant, *Secretary*

Consumer Members

G.A. Andersen, New York City Bureau of Water Supply, Corona, N.Y.	(AWWA)
J.H. Bambei Jr., Denver Water Department, Denver, Colo.	(AWWA)

D.W. Coppes, Massachusetts Water Resources Authority, Boston, Mass.	(AWWA)
R.V. Frisz, US Bureau of Reclamation, Denver, Colo.	(BUREC)
T.J. Jordan, Metropolitan Water District of Southern California, La Verne, Calif.	(AWWA)
T.A. Larson, Tacoma Water Division, Tacoma, Wash.	(AWWA)
A.L. Lindard, Los Angeles Water & Power, Los Angeles, Calif.	(AWWA)
G.P. Stine, San Diego County Water Authority, San Diego, Calif.	(AWWA)
J.V. Young, EPCOR Water Services, Richmond, B.C.	(AWWA)

General Interest Members

Ergun Bakall, AKM Consulting Engineers, Irvine, Calif.	(AWWA)
W.R. Brunzell, Brunzell Associates Ltd., Skokie, Ill.	(AWWA)
R.L. Coffey, Kirkham Michael Consulting Engineers, Omaha, Neb.	(AWWA)
H.E. Dunham, Montgomery Watson Harza, Bellevue, Wash.	(AWWA)
L.J. Farr, CH2M Hill Inc., Redding, Calif.	(AWWA)
K.G. Ferguson,* Montgomery Watson Harza, Las Vegas, Nev.	(AWWA)
S.N. Foellmi, Black & Veatch LLP, Irvine, Calif.	(AWWA)
J.W. Green, Alvord Burdick & Howson, Lisle, Ill.	(AWWA)
K.D. Henrichsen, HDR Engineering Inc., Denver, Colo.	(AWWA)
M.B. Horsley,* Black & Veatch LLP, Overland Park, Kan.	(AWWA)
J.K. Jeyapalan, Engineering Consultant, New Milford, Conn.	(AWWA)
Rafael Ortega, Lockwood Andrews & Newnam Inc., Houston, Texas	(AWWA)
A.E. Romer, Boyle Engineering Corporation, Newport Beach, Calif.	(AWWA)
H.R. Stoner, Consultant, North Plainfield, N.J.	(AWWA)
Chris Sundberg,* CH2M Hill Inc., Bellevue, Wash.	(AWWA)
G.J. Tupac, G.J. Tupac & Associates Inc., Pittsburgh, Pa.	(AWWA)
J.S. Wailes,† Standards Engineer Liaison, AWWA, Denver, Colo.	(AWWA)
L.W. Warren, Tetra Tech, Seattle, Wash.	(AWWA)
W.R. Whidden, Post Buckley Schuh & Jernigan, Orlando, Fla.	(AWWA)

*Alternate

†Liaison, nonvoting

Producer Members

H.H. Bardakjian, Ameron Concrete & Steel Pipe, Rancho Cucamonga, Calif.	(AWWA)
R.J. Card, Brico Industries Inc., Atlanta, Ga.	(AWWA)
R.R. Carpenter, American Cast Iron Pipe Company, Birmingham, Ala.	(MSS)
Dennis Dechant, Northwest Pipe Company, Denver, Colo.	(AWWA)
J.E. Hagelskamp,* American Cast Iron Pipe Company, Maitland, Fla.	(AWWA)
B.D. Keil, Continental Pipe Manufacturing Company, Pleasant Grove, Utah	(SPFA)
Bruce Vanderploeg,† Northwest Pipe Company, Portland, Ore.	(AWWA)
J.A. Wise, Canus Industries Inc., Port Coquitlam, B.C.	(AWWA)

*Liaison, nonvoting

†Alternate

This page intentionally blank.

Contents

All AWWA standards follow the general format indicated subsequently. Some variations from this format may be found in a particular standard.

SEC.	PAGE	SEC.	PAGE
Foreword		5	Verification
I	Introduction.....	5.1	Inspection by the Purchaser.....
I.A	Background.....	5.2	Mill Test Reports.....
I.B	History.....	6	Delivery
I.C	Acceptance.....	6.1	Markings.....
II	Special Issues.....	Appendix	
III	Use of This Standard.....	A	Bibliography.....
III.A	Purchaser Options and Alternatives.....		
III.B	Modification to Standard.....	Figures	
IV	Major Revisions.....	1	Attachment of Flange.....
V	Comments.....	2	Draft or Layback Measurement.....
Standard		Tables	
1	General	1	Flange Gasket Materials, Type and Thickness.....
1.1	Scope.....	2	AWWA Standard Steel-Ring Flanges, Class B (86 psi) and Class D (175–150 psi).....
1.2	Purpose.....	3	AWWA Standard Steel-Hub Flanges, Class D (175–150 psi).....
1.3	Application.....	4	AWWA Standard Steel-Hub Flanges, Class E (275 psi).....
2	References.....	5	AWWA Standard Steel-Ring Flanges, Class E (275 psi).....
3	Definitions.....	6	AWWA Standard Steel-Ring Flanges, Class F (300 psi).....
4	Requirements	7	AWWA Blind-Flange Thickness.....
4.1	Material.....		
4.2	Fabrication.....		
4.3	Method of Attachment of Flanges.....		
4.4	Protective Coating.....		

This page intentionally blank.

Foreword

This foreword is for information only and is not a part of AWWA C207.

I. Introduction.

I.A. *Background.* Steel flanges have been used with steel pipe in the waterworks field since the first riveted steel water-supply lines were installed with flanges attached by riveting. Flanges manufactured according to unofficial flange standards, such as the riveted-pipe manufacturer's standards, were in common use for 50 years or more before the advent of AWWA C207. Steel-plate ring flanges and rolled-angle flanges, to match the drilling of existing cast valves and cast fittings, were also used extensively.

The greatly increased usage of steel pipe for waterworks service during the 1930s made standardization of flanges desirable. The first step toward standardization was taken in 1942 when a paper^{*} proposing standards for slip-on steel-ring flanges for welding to steel water pipe was presented at the annual conference of the American Water Works Association (AWWA).

In 1945, at the request of the American Society of Mechanical Engineers (ASME), a committee having representatives from both the ASME and the AWWA was formed. The ASME/AWWA committee was charged with establishing standards for steel flanges having dimensions and pressure ratings commensurate with the pressures commonly used in waterworks service. The standards were necessary because the lowest pressure ratings for steel flanges at that time were those having cold-water pressure ratings of 275 psi (1,896 kPa) (ANSI[†]/ASME[‡] B16.5, Pipe Flanges and Flanged Fittings) (150-psi [1,034-kPa] primary pressure rating). The ratings were far higher than those ordinarily needed for water service.

The generally accepted rules for the design of bolted flanged connections embraced all fields of usage and a wide range of pressure and temperature applications. In waterworks practice, it is not necessary, within the scope of this standard, to deal with temperatures greater than the atmospheric range, and it is

^{*}Hill, H.O., et al, Fabricated Steel Ring Flanges for Water Pipe Service for Low Pressure and Low Temperatures, *Jour. AWWA* 36(9):968 (September 1944).

[†]American National Standards Institute, 25 W. 43rd St., Fourth Floor, New York, NY 10036

[‡]American Society of Mechanical Engineers, Three Park Avenue, New York, NY 10016-5990

possible to restrict consideration to joints with softer gaskets and to flanges that are flat faced. The designs were prepared in conformity with these limitations.

The ASME/AWWA committee gave careful consideration to the following: (1) the effect of new standards on existing equipment; (2) the fact that cast valves and fittings will always have flanges of large outside diameter, which cannot be reduced because of the wall thickness of this equipment; (3) the need for interchangeability of equipment through the medium of common drilling templates; and (4) the fact that standards could be based on the successful usage and good service records of existing installations.

A survey of water utility users indicated that it was desirable to maintain the outside diameter and drilling of flanged fittings and valves given in ANSI/AWWA C500, Standard for Gate Valves for Water and Sewage Systems, and ANSI/AWWA B16.1, Cast Iron Pipe Flanges and Flanged Fittings (for classes 25, 125, 250, and 800). The committee decided to follow this practice for sizes 6 in. (150 mm) through 48 in. (1,200 mm).

In its extensive deliberations, the ASME/AWWA committee had available the results of special research and testing conducted by Armco Steel Corporation, Bethlehem Steel Company, and Taylor Forge and Pipe Works. The various design methods and test results are given in "Steel Ring Flanges for Steel Pipe," Bulletin 47-A (1947), from the American Rolling Mill Company, Middletown, Ohio. The design of flanges for waterworks service, with the results of the preceding report, was published in *Journal AWWA* in October 1950, pp. 931–944. A discussion in the paper by Taylor Forge, participants in the ASME/AWWA committee, states the reasons why a waterworks flange is not an ASME/Taylor Forge flange. Concern about high secondary stresses at the attachment, e.g., thick material to thin wall pipe is covered here along with the published "Design of Wye Branches." (*Journal AWWA* June 1955, Appendix C, pp. 581–630).

I.B. *History.* The report of the ASME/AWWA committee was approved in 1951, and the first edition of this standard, designated C207-52T, was published under the title "Tentative Standard Specifications For Steel Pipe Flanges" in 1952. That edition covered diameters from 6 in. to 48 in. (150 mm to 1,200 mm) and pressures through 150 psi (1,034 kPa). In 1954, a committee composed of Taylor Forge, Armco, Bethlehem, and consulting engineers revised the existing standard to include diameters through 96 in. (2,400 mm) and pressures to 275 psi (1,896 kPa). This revision was published under designation AWWA C207-55, Standard Specifications/

Standard For Steel Pipe Flanges. The standard was further revised and the next edition published in 1978 as AWWA C207-78, Standard For Steel Pipe Flanges For Waterworks Service—Sizes 4 In. Through 144 In. The next edition, designated C207-86 with the same title, was published in 1986 and revised the maximum test pressure to 125 percent of the flange rating, added segmentation of flanges, blind flanges, class E ring flanges, class F ring and hub flanges, and tolerances for flange draft or layback. This edition was approved on June 17, 2001.

I.C. *Acceptance.* In May 1985, the US Environmental Protection Agency (USEPA) entered into a cooperative agreement with a consortium led by NSF International (NSF) to develop voluntary third-party consensus standards and a certification program for all direct and indirect drinking water additives. Other members of the original consortium included the American Water Works Association Research Foundation (AWWARF) and the Conference of State Health and Environmental Managers (COSHEM). The American Water Works Association (AWWA) and the Association of State Drinking Water Administrators (ASDWA) joined later.

In the United States, authority to regulate products for use in, or in contact with, drinking water rests with individual states.* Local agencies may choose to impose requirements more stringent than those required by the state. To evaluate the health effects of products and drinking water additives from such products, state and local agencies may use various references, including

1. An advisory program formerly administered by USEPA, Office of Drinking Water, discontinued on Apr. 7, 1990.
2. Specific policies of the state or local agency.
3. Two standards developed under the direction of NSF, ANSI[†]/NSF[‡] 60, Drinking Water Treatment Chemicals—Health Effects, and ANSI/NSF 61, Drinking Water System Components—Health Effects.
4. Other references, including AWWA standards, *Food Chemicals Codex*, *Water Chemicals Codex*,[§] and other standards considered appropriate by the state or local agency.

*Persons in Canada, Mexico, and non-North American countries should contact the appropriate authority having jurisdiction.

†American National Standards Institute, 25 W. 43rd St., Fourth Floor, New York, NY 10036

‡NSF International, 789 N. Dixboro Rd., Ann Arbor, MI 48105.

§Both publications available from National Academy of Sciences, 2102 Constitution Ave. N.W., Washington, DC 20418.

Various certification organizations may be involved in certifying products in accordance with ANSI/NSF 61. Individual states or local agencies have authority to accept or accredit certification organizations within their jurisdiction. Accreditation of certification organizations may vary from jurisdiction to jurisdiction.

Annex A, “Toxicology Review and Evaluation Procedures,” to ANSI/NSF 61 does not stipulate a maximum allowable level (MAL) of a contaminant for substances not regulated by a USEPA final maximum contaminant level (MCL). The MALs of an unspecified list of “unregulated contaminants” are based on toxicity testing guidelines (noncarcinogens) and risk characterization methodology (carcinogens). Use of Annex A procedures may not always be identical, depending on the certifier.

ANSI/AWWA C207-01 does not address additives requirements. Thus, users of this standard should consult the appropriate state or local agency having jurisdiction in order to

1. Determine additives requirements, including applicable standards.
2. Determine the status of certifications by all parties offering to certify products for contact with, or treatment of, drinking water.
3. Determine current information on product certification.

II. Special Issues. It should be noted that thickness and dimensional design of ring and hub flanges have been based on references given in the background section of this foreword, as well as industry standard and other empirical data. Thickness design of the blind flanges has been based on the ASME Code Design Method.

III. Use of This Standard. AWWA has no responsibility for the suitability or compatibility of the provisions of this standard to any intended application by any user. Accordingly, each user of this standard is responsible for determining that the standard’s provisions are suitable for and compatible with that user’s intended application.

III.A. Purchaser Options and Alternatives. When purchasing steel flanges for steel water pipe, the purchaser shall make specific statements in the specifications regarding the following:

1. Standard used—that is, AWWA C207, Standard for Steel Pipe Flanges for Waterworks Service-Sizes—4 In. Through 144 In. (100 mm Through 3,600 mm), of latest edition.
2. Type of flanges required—ring or hub type (Sec. 1.1).
3. Pressure rating required (Tables 2 through 7).

4. Class of flange required (Tables 2 through 7).
5. Inside diameter of flanges (Tables 2 through 7).
6. Gaskets—rubber or nonasbestos (Sec. 4.1.3) and gasket thickness for diameters up to and including 24 in. (610 mm).
7. Coating selection (Sec. 4.4).

III.B. *Modification to Standard.* Any modification to the provisions, definitions, or terminology in the standard must be provided in the purchaser's specifications.

IV. Major Revisions. Major revisions made to the standard in this revision include the following:

1. Sec. 1.3.2.6 was revised to indicate tabularized values developed using a design stress of 16,000 psi.
2. Sec. 4.1.2, Bolting, wording was added to indicate nuts shall be ASTM A194 grade 2H.
3. Sec. 4.1.3, Gaskets, temperature value for nonasbestos gaskets changed to 250°F (121°C).
4. Figures 1 and 2, minor changes and deletions were made.
5. Table 2 through 6, minor corrections were made.
6. Table 7, was completely revised.

V. Comments. If you have any comments or questions about this standard, please call the AWWA Volunteer & Technical Support Group, (303) 794-7711 ext. 6283, FAX (303) 795-7603, or write to the group at 6666 W. Quincy Ave., Denver, CO 80235.

This page intentionally blank.



AWWA STANDARD FOR

STEEL PIPE FLANGES FOR

WATERWORKS SERVICE—

SIZES 4 IN. THROUGH 144 IN.

(100 MM THROUGH 3,600 MM)

SECTION 1: GENERAL

Sec. 1.1 Scope

This standard describes two types of slip-on flanges, ring-type and hub-type, that may be used interchangeably if the dimensions given in the standard are used. The standard also describes blind flanges. The flange types and the tables that describe them are

1. Ring-type, slip-on flanges (see Tables 2, 5, and 6).
2. Hub-type, slip-on flanges (see Tables 3 and 4).
3. Blind Flanges (see Table 7).

Unless otherwise specified by the purchaser, the manufacturer will select the type to be used.

Sec. 1.2 Purpose

The purpose of this standard is to provide purchasers and manufacturers minimum material requirements and dimensions for a variety of steel flanges for attachment to steel water pipe and fittings.

Sec. 1.3 Application

1.3.1 *Intended use.* Flanges in this standard are intended for use with steel pipe, fittings, or appurtenances meeting the requirements of ANSI/AWWA C200, ANSI/AWWA C208, ASTM A134, ASTM A139, or other equivalent standards. It is intended that flanges be attached by welding in accordance with Sec. 4.3 of this standard.

1.3.2 *Pressure ratings.* The following pressure ratings apply to flanges described in this standard:

1.3.2.1 Class B flanges are suitable for pressure ratings up to and including 86 psi (593 kPa). This rating is identical to that for class B cast-iron fittings for a 200 ft (60.96-m) head of water.

1.3.2.2 Class D flanges are suitable for pressure ratings as follows:

1. Sizes 4–12 in. (100–300 mm): 175 psi (1,207 kPa).
2. Sizes greater than 12 in. (300 mm): 150 psi (1,034 kPa).

1.3.2.3 Class E flanges are suitable for pressure ratings up to and including 275 psi (1,896 kPa). Dimensions of Table 4 flanges are identical to ANSI/ASME B16.5 class 150 flanges up to 24 in. (600 mm) (without raised face), and ANSI/ASME B16.1 class 125 large diameter flanges above 24 in. (600 mm) (without raised face), except they shall be faced in accordance with Sec. 4.2.2 of this standard.

1.3.2.4 Class F flanges are suitable for water pressures up to and including 300 psi (2,068 kPa). Flange outside diameter (OD) and bolt-circle dimensions conform to ANSI/ASME B16.1, class 250 through 48 in. (1,200 mm), ANSI/ASME B16.5 class 300 through 24 in. (600 mm) and ASME B16.47 class 300 for 26–30 in. (650–750 mm).

1.3.2.5 Pressure ratings are for conditions and temperatures customary in water utility service. The pressure ratings for the flange should be based on the design of the maximum operating pressure plus the anticipated surge pressure. Test pressures should not exceed 125 percent of the ratings.

1.3.2.6 Flange design is based on pressure considerations, not for stresses induced by external moments when pipe acts as a beam. The tables in this standard have been developed using a design stress of 16,000 psi for the working pressure design.

SECTION 2: REFERENCES

This standard references the following documents. In their latest editions, they form a part of this standard to the extent specified in this standard. In any case of conflict, the requirements of this standard shall prevail.

ANSI^{*}/ASME B1—Unified Inch Screw Threads (UN and UNR Thread Form).

ANSI/ASME B16.1—Cast Iron Pipe Flanges and Flanged Fittings.

ANSI/ASME B16.5—Pipe Flanges and Flanged Fittings.

ANSI/ASME B18.2.1—Square and Hex Bolts and Screws (Inch Series).

ANSI/ASME B18.2.2—Square and Hex Nuts (Inch Series).

ASME[†]—Boiler and Pressure Vessel Codes—Section VIII, Pressure Vessels and Section IX, Welding Operator Qualification.

ASME B16.47—Large Diameter Steel Flanges: NPS 26 through NPS 60.

ANSI/ASME B36.10—Welded and Seamless Wrought Steel Pipe.

ASTM[‡] A36/A36M—Standard Specification for Carbon Structural Steel.

ASTM A105—Standard Specification for Carbon Steel Forgings for Piping Components.

ASTM A134—Standard Specification for Pipe, Steel, Electric-Fusion (Arc)-Welded (Sizes NPS 16 and Over).

ASTM A139—Standard Specification for Electric-Fusion (Arc)-Welded Steel Pipe (NPS 4 and Over).

ASTM A181/A181M—Standard Specification for Carbon Steel Forgings for General Purpose Piping.

ASTM A193/A193M—Standard Specification for Alloy-Steel and Stainless Steel Bolting Materials for High-Temperature Service.

ASTM A307—Standard Specification for Carbon Steel Bolts and Studs, 60,000 psi Tensile Strength.

ASTM A516—Standard Specification for Pressure Vessel Plates, Carbon Steel, for Moderate- and Lower-Temperature Service.

ASTM D1330—Standard Specification for Rubber Sheet Gaskets.

^{*}American National Standards Institute, Inc., 25 W. 43rd St., Fourth Floor, New York, NY 10036.

[†]American Society of Mechanical Engineers, Three Park Avenue, New York, NY 10016-5990.

[‡]American Society for Testing and Materials, 100 Barr Harbor Dr., West Conshohocken, PA 19428-2959.

AWS* D1.1—Standard Structural Welding Code—Steel.

ANSI/AWWA C200—Standard for Steel Water Pipe—6 In. (150 mm) and Larger.

ANSI/AWWA C203—Standard for Coal-Tar Protective Coatings and Linings for Steel Water Pipelines—Enamel and Tape—Hot-Applied.

ANSI/AWWA C205—Standard for Cement–Mortar Protective Lining and Coating for Steel Water Pipe—4 In. (100 mm) and Larger—Shop Applied.

ANSI/AWWA C206—Standard for Field Welding of Steel Water Pipe.

ANSI/AWWA C208—Standard for Dimensions for Fabricated Steel Water Pipe Fittings.

ANSI/AWWA C209—Standard for Cold-Applied Tape Coatings for the Exterior of Special Sections, Connections, and Fittings for Steel Water Pipelines.

ANSI/AWWA C210—Standard for Liquid-Epoxy Coating Systems for the Interior and Exterior of Steel Water Pipelines.

ANSI/AWWA C213—Standard for Fusion-Bonded Epoxy Coating for the Interior and Exterior of Steel Water Pipelines.

ANSI/AWWA C214 — Standard for Tape Coating Systems for the Exterior of Steel Water Pipelines.

ANSI/AWWA C215—Standard for Extruded Polyolefin Coatings for the Exterior of Steel Water Pipelines.

ANSI/AWWA C216—Standard for Heat-Shrinkable Cross-Linked Polyolefin Coatings for the Exterior of Special Sections, Connections, and Fittings for Steel Water Pipelines.

ANSI/AWWA C217—Standard for Cold-Applied Petrolatum Tape and Petroleum Wax Tape Coatings for the Exterior of Special Sections, Connections, and Fittings for Buried Steel Water Pipelines.

ANSI/AWWA C218—Standard for Coating the Exterior of Aboveground Steel Water Pipelines and Fittings.

*American Welding Society, 550 N.W. LeJeune Rd., Miami, FL 33135.

SECTION 3: DEFINITIONS

The following definitions shall apply in this standard:

1. *Manufacturer*: The party that manufactures, fabricates, or produces materials or products.
2. *Purchaser*: The person, company, or organization that purchases any materials or work to be performed.

SECTION 4: REQUIREMENTS

Sec. 4.1 Material

4.1.1 *Flanges*. Flanges shall be made from seamless forgings, cut from plate as a single piece, welded bar rings, or segmented and welded plates.

4.1.1.1 Forgings. Forgings shall meet the minimum requirements of ASTM A105 or A181.

4.1.1.2 Steel plate or bar. Steel plate or bar used in the manufacture of flanges shall meet the following requirements:

1. Tensile strength = 50,000 psi (345 MPa) (min).
2. Yield strength = 32,000 psi (221 MPa) (min).
3. Carbon (max) = 0.29 percent.
4. Phosphorous (max) = 0.04 percent.
5. Sulfur (max) = 0.05 percent.

The following plate designations will meet the previously listed requirements:

1. ASTM A36.
2. ASTM A516, grade 60, 65, or 70.

4.1.1.3 Mill test reports. The manufacturer shall provide mill test reports showing conformance to the physical and chemical requirements on request.

4.1.2 *Bolting*. Bolts shall be carbon steel, ASTM A307 grade B for class B & D flanges. Bolts for class E and F flanges shall be ASTM A193 grade B7. Nuts shall be ASTM A194 grade 2H. Bolts shall have regular unfinished square or hexagonal heads, and nuts shall have regular square or hexagonal dimensions, all in accordance with ANSI B18.2.1 for wrench head bolts and nuts and wrench openings.

Minimum bolt lengths shall be the sum of the mating flange maximum thicknesses, the gasket, and the depth of the nut plus $\frac{1}{8}$ in. (3.2 mm) minimum

before torquing. If threaded rods are used, they shall be the same length as the bolts determined previously, plus the depth of the nuts, plus $\frac{1}{8}$ in. (3.2 mm).

4.1.3 *Gaskets.* This standard is predicated on gaskets of the type, thickness, and material shown in Table 1 for the class of flange, working pressure, and diameter listed.

Rubber gaskets shall be red rubber (SBR) hardness (Shore A) 80 ± 5 , suitable for water service temperature to 200°F (93.3°C) with gasket yield pressure of 200 psi (1,379 kPa) minimum to 1,200 psi (8,274 kPa) maximum, conforming to ASTM D1330, grades I and II.

Nonasbestos gaskets shall be a blend of synthetic fibers, fillers, and elastomeric binders suitable for potable water service and temperature to 250°F (121.1°C). Gasket yield pressure shall be 3,600 psi (24.82 MPa) minimum for gaskets $\frac{1}{16}$ -in. (1.6-mm) thick and 4,800 psi (33.09 MPa) minimum for gasket $\frac{1}{8}$ -in. (3.2 mm) thick. Gasket shall be suitable for a maximum seating pressure of 15,000 psi (103.42 MPa).

Ring gasket diameter shall be as follows:

inside Diameter (ID) = flange ID

outside Diameter (OD) = ID of bolt-hole circle less $\frac{1}{16}$ in. (1.6 mm).

Table 1 Flange gasket materials, type and thickness

Flange Class	Working Pressure		Nominal Pipe Diameter		Material	Type	Thickness	
	<i>psi</i>	<i>(kPa)</i>	<i>in.</i>	<i>(mm)</i>			<i>in.</i>	<i>(mm)</i>
B	86	(593)	4–24	(100–600)	Rubber	FF*	$\frac{1}{16}$ or $\frac{1}{8}$	(1.59 or 3.18)
B	86	(593)	26–144	(650–3,600)	Rubber	Ring	$\frac{1}{8}$	(3.18)
D	175	(1,207)	4–12	(100–300)	Rubber	FF	$\frac{1}{16}$ or $\frac{1}{8}$	(1.59 or 3.18)
D	150	(1,034)	14–24	(350–600)	Rubber	FF	$\frac{1}{16}$ or $\frac{1}{8}$	(1.59 or 3.18)
D	150	(1,034)	26–144	(650–3,600)	Rubber	Ring	$\frac{1}{8}$	(3.18)
E	175	(1,207)	4–12	(100–300)	Rubber	Ring	$\frac{1}{16}$	(1.59)
E	150	(1,034)	14–24	(350–600)	Rubber	Ring	$\frac{1}{16}$	(1.59)
E	275	(1,896)	4–24	(100–600)	Nonasbestos	Ring	$\frac{1}{16}$	(1.59)
E	275	(1,896)	26–144	(650–3,600)	Nonasbestos	Ring	$\frac{1}{8}$	(3.18)
F	300	(2,068)	4–24	(100–600)	Nonasbestos	Ring	$\frac{1}{16}$	(1.59)
F	300	(2,068)	26–48	(650–1,200)	Nonasbestos	Ring	$\frac{1}{8}$	(3.18)

*Full faced.

Sec. 4.2 Fabrication

4.2.1 *Tolerances.* The dimensions listed in Tables 2 through 7 (following Sec. 6.1) shall apply prior to attachment and are subject to the following tolerances:

4.2.1.1	Inside diameter of flange	+ $\frac{1}{16}$ in. (1.6 mm), -0
4.2.1.2	Outside diameter of flange	$\pm \frac{1}{8}$ in. (3.2 mm)
4.2.1.3	Thickness of flanges 18 in. (450 mm) and smaller	+ $\frac{1}{8}$ in. (3.2 mm), -0
4.2.1.4	Thickness of flanges 20 in. (500 mm) and larger	+ $\frac{3}{16}$ in. (4.8 mm), -0
4.2.1.5	Length through hub 18 in. (450 mm) and smaller	+ $\frac{1}{8}$ in. (3.2 mm), - $\frac{1}{32}$ in. (0.79 mm)
4.2.1.6	Length through hub 20 in. (500 mm) and larger	+ $\frac{3}{16}$ in. (4.8 mm), - $\frac{1}{16}$ in. (1.6 mm)
4.2.1.7	Bolt-circle diameter	$\pm \frac{1}{16}$ in. (1.6 mm)
4.2.1.8	Bolt-hole spacing	$\pm \frac{1}{32}$ in. (0.79 mm)

4.2.2 *Facing.* Flanges of all classes shall be flat faced—that is, without projection or raised face. Either a serrated concentric or serrated spiral finish having from 24 grooves/in. to 40 grooves/in. (0.94 to 1.57 grooves/mm) shall be used. The cutting tool employed shall have an approximate 0.06 in. (1.52 mm) or larger radius. The resultant surface finish shall have a 250- to 500- μ in. (6.35- to 12.7- μ m) roughness.

4.2.3 *Drilling.* Drilling templates are in multiples of four so that fittings can be made to face any quarter. Bolt holes shall straddle the center line, except where special mating conditions exist, and shall be drilled $\frac{1}{8}$ in. (3.2 mm) larger in diameter than the nominal diameter of the bolt, except on flanges larger than 84 in. (2,100 mm) diameter, bolt holes shall be drilled $\frac{3}{16}$ in. (4.8 mm) larger than the nominal bolt diameter. Bolt holes may be overdrilled by an additional $\frac{1}{8}$ in. (3.2 mm) to accommodate insulators or to facilitate alignment with the mating flange.

4.2.4 *Segmentation of flanges.* Construction of flanges by welding segments together will be necessary when the OD of a flange exceeds the width of available plate material (approximately 78-in. [1,950-mm] ID and larger). A maximum of four segments are allowed in a single flange.

4.2.4.1 Welding of the segments shall be performed in accordance with Sec. 4.3.2 of this standard.

4.2.4.2 Radiographic or ultrasonic testing of all welds is required and shall be performed in accordance with the governing welding code selected in Sec. 4.3.2.

4.2.4.3 If any specimen tested in accordance with the approved procedure fails to meet the requirements, it shall be repaired using the approved repair procedure and radiographically or ultrasonically tested for conformance. If the retest fails to conform to the requirements, the flange shall be rejected.

4.2.4.4 Segmented flanges shall be stress-relieved by a method acceptable to the purchaser. Stress relieving shall be done after welding and before machining.

4.2.5 *Blind flanges.* Blind flange thicknesses shall be as set forth in Table 7. For blind flanges over 48-in. (1,200-mm) nominal diameter, it is recommended that a combination of a ring flange and a flanged and dished head, suitable for the pressure and design conditions, be used. Blind flanges shall be machine faced to match the mating flange. The thickness shown in Table 7 is after machining.

Sec. 4.3 Method of Attachment of Flanges

4.3.1 *Welding.* Flanges shall be attached to pipe, fittings, or other appurtenances by means of two fillet welds of the size shown in Figure 1. Whenever attachment by this means is not practical, the flanges may be attached by welds similar to those described in Section VIII, Division 1, of the ASME Boiler and Pressure Vessel Code.

4.3.2 *Welding procedure and qualification.* All welds performed in the attachment of flanges, welding of segments of flanges, and the repair of welding defects shall conform to a written procedure developed by the manufacturer. This procedure shall be available to the purchaser on request for review, approval, or modification.

The procedure used shall be based on a current, applicable welding code, such as ANSI/AWS D1.1 or ASME Boiler and Pressure Vessel Code, Section IX.

4.3.2.1 *Welder and welding operator qualification.* Welders and welding operators shall be qualified under Section IX, of the ASME Boiler and Pressure Vessel Code; applicable parts of ANSI/AWS D1.1; or other approved procedure.

4.3.3 *Draft or layback tolerance.* After welding of the flange has been completed, a draft or layback of the flange face may occur as shown in Figure 2. Total draft or layback shall not exceed $1\frac{1}{2}^\circ$ between two mating flanges. Negative draft will not be permitted.

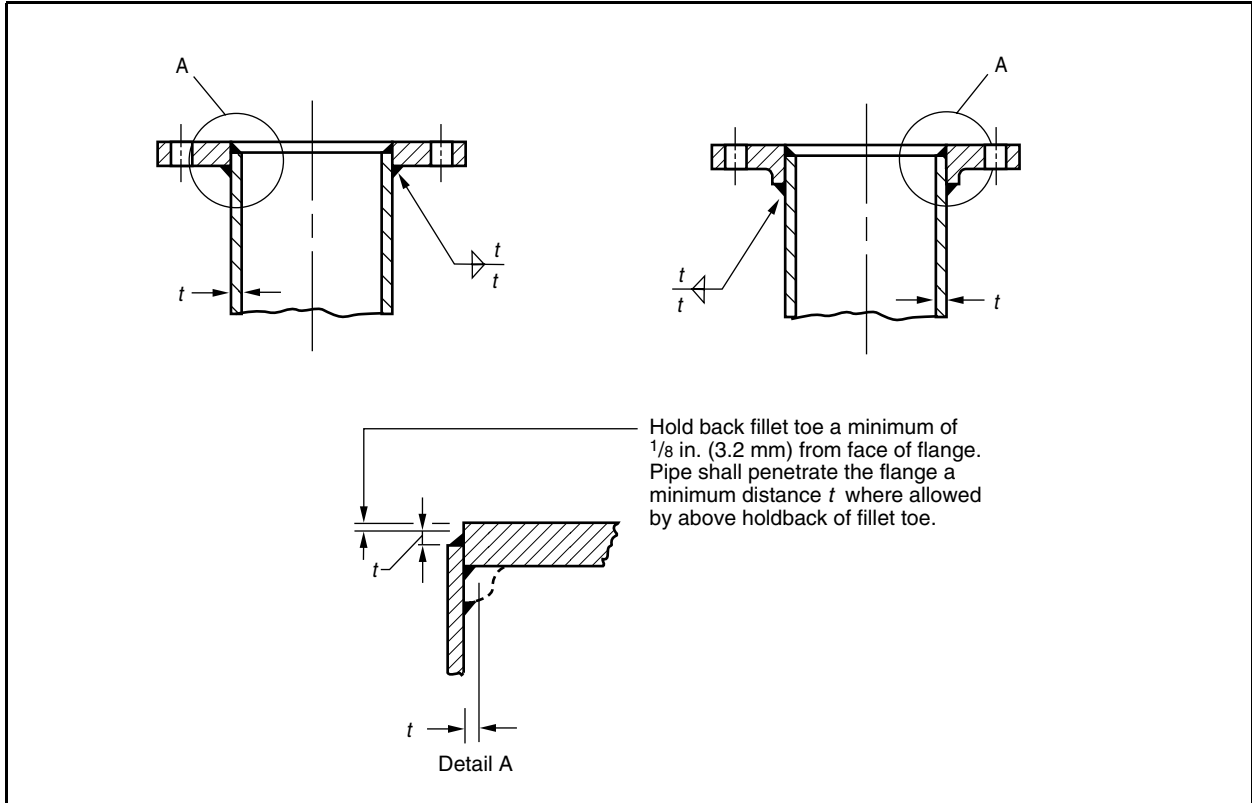
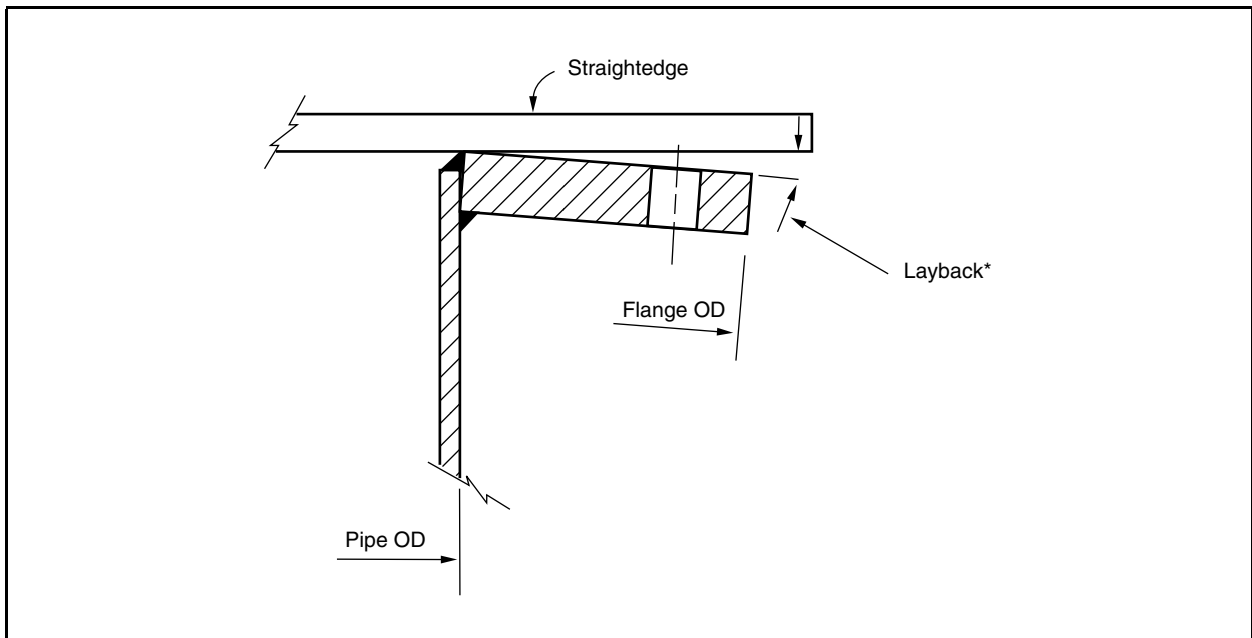

Figure 1 Attachment of flange



*Before the flange bolts are torqued, the maximum total draft or layback shall be limited to 1° for a single flange or a maximum of 1 1/2° total for two mating surfaces.

Figure 2 Draft or layback measurement

4.3.4 *Welding technique.* Care shall be taken during the welding process to avoid warping the flange face, particularly when attaching the class B flanges.

Sec. 4.4 Protective Coating

If specified by the purchaser, the flanges or flanged joints shall be given a protective coating conforming to ANSI/AWWA C203, ANSI/AWWA C205, ANSI/AWWA C209, ANSI/AWWA C210, ANSI/AWWA C213, ANSI/AWWA C214, ANSI/AWWA C215, ANSI/AWWA C216, ANSI/AWWA C217, ANSI/AWWA C218, or some combination of these coatings.

SECTION 5: VERIFICATION

Sec. 5.1 Inspection by the Purchaser

5.1.1 *Optional inspection.* At the purchaser's option, flange dimensions and attachment to pipe by welding may be inspected by the purchaser. This inspection shall not relieve the manufacturer of the responsibility to furnish material and perform work in accordance with this standard.

5.1.2 *Access and facilities.* The purchaser shall have access at all reasonable times to those parts of the manufacturer's plant involved in the manufacture of the material ordered while the work contracted is being performed. The manufacturer shall provide the purchaser with the facilities necessary to determine that the material is being furnished in accordance with this standard. Inspections shall be made at the place of manufacture prior to shipment.

5.1.3 *Rejection.* The purchaser may reject any flanges that do not conform to the requirements of this standard and the purchaser's specifications.

Sec. 5.2 Mill Test Reports

Mill test reports may be requested as stated in Sec. 4.1.1.3.

SECTION 6: DELIVERY

Sec. 6.1 Markings

Flanges shall be stamped with the size and name or trademark of the manufacturer and with the AWWA class as defined in Sec. 1.3.2.

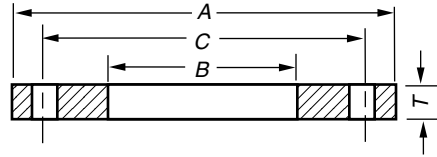
 Table 2 AWWA standard steel-ring flanges, class B* (86 psi) and Class D[†] (175–150 psi)

Nominal Pipe Size <i>in.</i>	OD of Flange (A) <i>in.</i>	ID of Flange (B [‡]) <i>in.</i>	Number of Bolts	Diam. of Bolt Circle (C) <i>in.</i>	Diam. of Bolts [§] <i>in.</i>	Thickness of Flange — <i>in.</i>	
						Class B (T)	Class D (T)
4	9.00	4.57	8	7.50	0.625	0.625	0.625
5	10.00	5.66	8	8.50	0.750	0.625	0.625
6	11.00	6.72	8	9.50	0.750	0.688	0.688
8	13.50	8.72	8	11.75	0.750	0.688	0.688
10	16.00	10.88	12	14.25	0.875	0.688	0.688
12	19.00	12.88	12	17.00	0.875	0.688	0.812
14	21.00	14.19	12	18.75	1.000	0.688	0.938
16	23.50	16.19	16	21.25	1.000	0.688	1.000
18	25.00	18.19	16	22.75	1.125	0.688	1.062
20	27.50	20.19	20	25.00	1.125	0.688	1.125
22	29.50	22.19	20	27.25	1.250	0.750	1.188
24	32.00	24.19	20	29.50	1.250	0.750	1.250
26	34.25		24	31.75	1.250	0.812	1.312
28	36.50		28	34.00	1.250	0.875	1.312
30	38.75		28	36.00	1.250	0.875	1.375
32	41.75		28	38.50	1.500	0.938	1.500
34	43.75		32	40.50	1.500	0.938	1.500
36	46.00		32	42.75	1.500	1.000	1.625
38	48.75		32	45.25	1.500	1.000	1.625
40	50.75		36	47.25	1.500	1.000	1.625
42	53.00		36	49.50	1.500	1.125	1.750
44	55.25		40	51.75	1.500	1.125	1.750

NOTES:

1. Ring flanges may be overbored or counterbored to accommodate larger outside-diameter pipe than shown as nominal. This is done to allow a clear inside diameter after cement–mortar lining. Wrench clearance between the pipe OD and bolt circle must be maintained as well as sufficient gasket seating area.

2. Metric conversion: nominal pipe size: $\text{in.} \times 25 = \text{mm}$; dimensions: $\text{in.} \times 25.4 = \text{mm}$; $\text{psi} \times 6.895 = \text{kPa}$

*Pressure rating at atmospheric temperature is 86 psi. These flanges have the same OD and drilling as class 125 cast-iron flanges (ANSI/ASME B16.1). In sizes 24 in. and smaller, they also match ANSI/ASME B16.5 150 psi drilling for steel flanges.

†Pressure rating at atmospheric temperature: sizes 4–12 in. inclusive, 175 psi; sizes larger than 12 in., 150 psi. These flanges have the same diameter and drilling as class 125 cast-iron flanges (ANSI/ASME B16.1). In sizes 24 in. and smaller, they also match ANSI/ASME B16.5 150-psi standard for steel flanges.

‡The purchaser shall specify the ID of the flange, dimension B, for nominal pipe sizes 26 in. and larger. The diameter of the flange bore shall not exceed the pipe OD by more than 0.19 in.

§Bolt holes shall be drilled $\frac{1}{8}$ -in. larger in diameter than the nominal diameter of the bolt except as stated in Sec. 4.2.3.

Table 2 AWWA standard steel-ring flanges, class B* (86 psi) and Class D† (175–150 psi)—cont.

Nominal Pipe Size <i>in.</i>	OD of Flange (A) <i>in.</i>	ID of Flange (B‡) <i>in.</i>	Number of Bolts	Diam. of Bolt Circle (C) <i>in.</i>	Diam. of Bolts§ <i>in.</i>	Thickness of Flange — <i>in.</i>	
						Class B (T)	Class D (T)
46	57.25		40	53.75	1.500	1.125	1.750
48	59.50		44	56.00	1.500	1.250	1.875
50	61.75		44	58.25	1.750	1.250	2.000
52	64.00		44	60.50	1.750	1.250	2.000
54	66.25		44	62.75	1.750	1.375	2.125
60	73.00		52	69.25	1.750	1.500	2.250
66	80.00		52	76.00	1.750	1.625	2.500
72	86.50		60	82.50	1.750	1.750	2.625
78	93.00		64	89.00	2.000	2.000	2.750
84	99.75		64	95.50	2.000	2.000	2.875
90	106.50		68	102.00	2.250	2.250	3.000
96	113.25		68	108.50	2.250	2.250	3.250
102	120.00		72	114.50	2.500	2.500	3.250
108	126.75		72	120.75	2.500	2.500	3.375
114	133.50		76	126.75	2.750	2.750	3.500
120	140.25		76	132.75	2.750	2.750	3.500
126	147.00		80	139.25	3.000	3.000	3.750
132	153.75		80	145.75	3.000	3.000	3.875
138	160.50		84	152.00	3.250	3.250	4.000
144	167.25		84	158.25	3.250	3.250	4.125

NOTES:

1. Ring flanges may be overbored or counterbored to accommodate larger outside-diameter pipe than shown as nominal. This is done to allow a clear inside diameter after cement–mortar lining. Wrench clearance between the pipe OD and bolt circle must be maintained as well as sufficient gasket seating area.

2. Metric conversion: nominal pipe size: $\text{in.} \times 25 = \text{mm}$; dimensions: $\text{in.} \times 25.4 = \text{mm}$; $\text{psi} \times 6.895 = \text{kPa}$

*Pressure rating at atmospheric temperature is 86 psi. These flanges have the same OD and drilling as class 125 cast-iron flanges (ANSI/ASME B16.1). In sizes 24 in. and smaller, they also match ANSI/ASME B16.5 150 psi drilling for steel flanges.

†Pressure rating at atmospheric temperature: sizes 4–12 in. inclusive, 175 psi; sizes larger than 12 in., 150 psi. These flanges have the same diameter and drilling as class 125 cast-iron flanges (ANSI/ASME B16.1). In sizes 24 in. and smaller, they also match ANSI/ASME B16.5 150-psi standard for steel flanges.

‡The purchaser shall specify the ID of the flange, dimension B, for nominal pipe sizes 26 in. and larger. The diameter of the flange bore shall not exceed the pipe OD by more than 0.19 in.

§Bolt holes shall be drilled $\frac{1}{8}$ -in. larger in diameter than the nominal diameter of the bolt except as stated in Sec. 4.2.3.

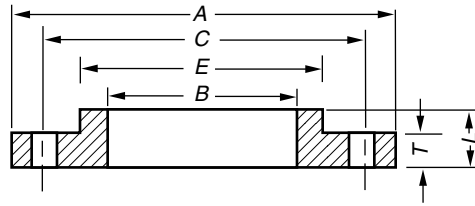

Table 3 AWWA standard steel-hub flanges, class D* (175–150 psi)

Nominal Pipe Size <i>in.</i>	OD of Flange (A) <i>in.</i>	ID of Flange (B) <i>in.</i>	Number of Bolts	Diam. of Bolt Circle (C) <i>in.</i>	Diam of Bolts [†] <i>in.</i>	Flange Dimensions — <i>in.</i>		
						(T)	(L)	(E)
4	9.00	4.57	8	7.50	0.625	0.500	0.875	5.312
5	10.00	5.66	8	8.50	0.750	0.562	1.250	6.312
6	11.00	6.72	8	9.50	0.750	0.562	1.250	7.562
8	13.50	8.72	8	11.75	0.750	0.562	1.250	9.688
10	16.00	10.88	12	14.25	0.875	0.688	1.250	12.000
12	19.00	12.88	12	17.00	0.875	0.688	1.250	14.375
14	21.00	14.19	12	18.75	1.000	0.750	1.250	15.750
16	23.50	16.19	16	21.25	1.000	0.750	1.250	18.000
18	25.00	18.19	16	22.75	1.125	0.750	1.250	19.875
20	27.50	20.19	20	25.00	1.125	0.750	1.250	22.000
22	29.50	22.19	20	27.25	1.250	1.000	1.750	24.250
24	32.00	24.19	20	29.50	1.250	1.000	1.750	26.125
26	34.25	26.19	24	31.75	1.250	1.000	1.750	28.500
28	36.50	28.19	28	34.00	1.250	1.000	1.750	30.500
30	38.75	30.19	28	36.00	1.250	1.000	1.750	32.500
32	41.75	32.19	28	38.50	1.500	1.125	1.750	34.750
34	43.75	34.19	32	40.50	1.500	1.125	1.750	36.750
36	46.00	36.19	32	42.75	1.500	1.125	1.750	38.750
38	48.75	38.19	32	45.25	1.500	1.125	1.750	40.750
40	50.75	40.19	36	47.25	1.500	1.125	1.750	43.000
42	53.00	42.19	36	49.50	1.500	1.250	1.750	45.000
44	55.25	44.19	40	51.75	1.500	1.250	2.250	47.000
46	57.25	46.19	40	53.75	1.500	1.250	2.250	49.000
48	59.50	48.19	44	56.00	1.500	1.375	2.500	51.000
50	61.75	50.19	44	58.25	1.750	1.375	2.500	53.000
52	64.00	52.19	44	60.50	1.750	1.375	2.500	55.000
54	66.25	54.19	44	62.75	1.750	1.375	2.500	57.000

NOTES:

1. Hub flanges are to be used on pipe that has an OD equal to the nominal pipe size in the first column and shall not be overbored.

2. Metric conversion: nominal pipe size: $\text{in.} \times 25 = \text{mm}$; dimensions: $\text{in.} \times 25.4 = \text{mm}$; $\text{psi} \times 6.895 = \text{kPa}$.

*Pressure rating at atmospheric temperature: sizes 4–12 in. inclusive, 175 psi; sizes larger than 12 in., 150 psi. These flanges have the diameter and drilling as class 125 cast-iron flanges (ANSI/ASME B16.1). In sizes 24 in. and smaller, they also match ANSI/ASME B16.5 150-psi standard for steel flanges.

†Bolt holes shall be drilled $\frac{1}{8}$ -in. larger in diameter than the nominal diameter of the bolt as stated in Sec. 4.2.3.

Table 3 AWWA standard steel-hub flanges, class D* (175–150 psi)—cont.

Nominal Pipe Size <i>in.</i>	OD of Flange (A) <i>in.</i>	ID of Flange (B) <i>in.</i>	Number of Bolts	Diam. of Bolt Circle (C) <i>in.</i>	Diam of Bolts [†] <i>in.</i>	Flange Dimensions — <i>in.</i>		
						(T)	(L)	(E)
60	73.00	60.19	52	69.25	1.750	1.500	2.750	63.000
66	80.00	66.19	52	76.00	1.750	1.500	2.750	69.000
72	86.50	72.19	60	82.50	1.750	1.500	2.750	75.000
78	93.00	78.19	64	89.00	2.000	1.750	3.000	81.250
84	99.75	84.19	64	95.50	2.000	1.750	3.000	87.500
90	106.50	90.19	68	102.00	2.250	2.000	3.250	93.750
96	113.25	96.19	68	108.50	2.250	2.000	3.250	100.000

NOTES:

1. Hub flanges are to be used on pipe that has an OD equal to the nominal pipe size in the first column and shall not be overbored.

2. Metric conversion: nominal pipe size: $\text{in.} \times 25 = \text{mm}$; dimensions: $\text{in.} \times 25.4 = \text{mm}$; $\text{psi} \times 6.895 = \text{kPa}$.

*Pressure rating at atmospheric temperature: sizes 4–12 in. inclusive, 175 psi; sizes larger than 12 in., 150 psi. These flanges have the diameter and drilling as class 125 cast-iron flanges (ANSI/ASME B16.1). In sizes 24 in. and smaller, they also match ANSI/ASME B16.5 150-psi standard for steel flanges.

†Bolt holes shall be drilled $1/8$ -in. larger in diameter than the nominal diameter of the bolt as stated in Sec. 4.2.3.

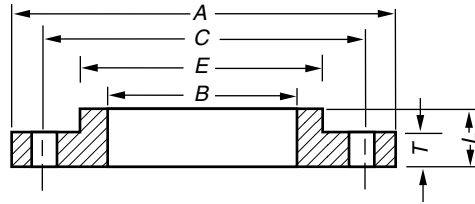

Table 4 AWWA standard steel-hub flanges, class E* (275 psi)

Nominal Pipe Size <i>in.</i>	OD of Flange (A) <i>in.</i>	ID of Flange (B [†]) <i>in.</i>	Number of Bolt	Diam. of Bolt Circle (C) <i>in.</i>	Diam. of Bolts [‡] <i>in.</i>	Flange Dimensions — <i>in.</i>		
						(T) [§]	(L)	(E)
4	9.00	4.57	8	7.50	0.625	0.938	1.312	5.312
5	10.00	5.66	8	8.50	0.750	0.938	1.438	6.438
6	11.00	6.72	8	9.50	0.750	1.000	1.562	7.562
8	13.50	8.72	8	11.75	0.750	1.125	1.750	9.688
10	16.00	10.88	12	14.25	0.875	1.188	1.938	12.000
12	19.00	12.88	12	17.00	0.875	1.250	2.188	14.375
14	21.00	14.19	12	18.75	1.000	1.375	2.250	15.750
16	23.50	16.19	16	21.25	1.000	1.438	2.500	18.000
18	25.00	18.19	16	22.75	1.125	1.562	2.688	19.875
20	27.50	20.19	20	25.00	1.125	1.688	2.875	22.000
22	29.50	22.19	20	27.25	1.250	1.812	3.125	24.000
24	32.00	24.19	20	29.50	1.250	1.875	3.250	26.125
26	34.25	26.19	24	31.75	1.250	2.000	3.375	28.500
28	36.50	28.19	28	34.00	1.250	2.062	3.438	30.750
30	38.75	30.19	28	36.00	1.250	2.125	3.500	32.750
32	41.75	32.19	28	38.50	1.500	2.250	3.625	35.000
34	43.75	34.19	32	40.50	1.500	2.312	3.688	37.000
36	46.00	36.19	32	42.75	1.500	2.375	3.750	39.250
38	48.75	38.19	32	45.25	1.500	2.375	3.750	41.750
40	50.75	40.19	36	47.25	1.500	2.500	3.875	43.750
42	53.00	42.19	36	49.50	1.500	2.625	4.000	46.000
44	55.25	44.19	40	51.75	1.500	2.625	4.000	48.000
46	57.25	46.19	40	53.75	1.500	2.688	4.062	50.000
48	59.50	48.19	44	56.00	1.500	2.750	4.125	52.250
50	61.75	50.19	44	58.25	1.750	2.750	4.125	54.250

Notes:

1. Hub flanges are to be used on pipe that has an OD equal to the nominal pipe size in the first column and shall not be overbored.

2. Metric conversion: nominal pipe size: $\text{in.} \times 25 = \text{mm}$; dimensions: $\text{in.} \times 25.4 = \text{mm}$; $\text{psi} \times 6.895 = \text{kPa}$.

*Pressure rating at atmospheric temperature is 275 psi. These flanges have the same diameter and drilling as ANSI B16.1, class 125 cast-iron flanges. In sizes 24 in. and smaller, they also match ANSI B16.5, 150 psi standard for steel flanges.

†Welding neck flanges may be used if desired, at the purchaser's option.

‡Bolt holes shall be drilled $\frac{1}{8}$ in. larger in diameter than the nominal diameter of the bolt as stated in Sec. 4.2.3.

§The thickness T of a flange from which the raised face has been removed, shall be no less than Dimension T minus 0.06 in.

Table 4 AWWA standard steel-hub flanges, class E* (275 psi)—cont.

Nominal Pipe Size <i>in.</i>	OD of Flange (A) <i>in.</i>	ID of Flange (B [†]) <i>in.</i>	Number of Bolt	Diam. of Bolt Circle (C) <i>in.</i>	Diam. of Bolts [‡] <i>in.</i>	Flange Dimensions — <i>in.</i>		
						(T) [§]	(L)	(E)
52	64.00	52.19	44	60.50	1.750	2.875	4.250	56.500
54	66.25	54.19	44	62.75	1.750	3.000	4.375	58.750
60	73.00	60.19	52	69.25	1.750	3.125	4.500	65.250
66	80.00	66.19	52	76.00	1.750	3.375	4.875	71.500
72	86.50	72.19	60	82.50	1.750	3.500	5.000	78.500
78	93.00	78.19	64	89.00	2.000	3.875	5.375	84.500
84	99.75	84.19	64	95.50	2.000	3.875	5.375	90.500
90	106.50	90.19	68	102.00	2.250	4.250	5.750	96.750
96	113.25	96.19	68	108.50	2.250	4.250	5.750	102.750

Notes:

1. Hub flanges are to be used on pipe that has an OD equal to the nominal pipe size in the first column and shall not be overbored.

2. Metric conversion: nominal pipe size: in. \times 25 = mm; dimensions: in. \times 25.4 = mm; psi \times 6.895 = kPa.

*Pressure rating at atmospheric temperature is 275 psi. These flanges have the same diameter and drilling as ANSI B16.1, class 125 cast-iron flanges. In sizes 24 in. and smaller, they also match ANSI B16.5, 150 psi standard for steel flanges.

†Welding neck flanges may be used if desired, at the purchaser's option.

‡Bolt holes shall be drilled $\frac{1}{8}$ in. larger in diameter than the nominal diameter of the bolt as stated in Sec. 4.2.3.

§The thickness *T* of a flange from which the raised face has been removed, shall be no less than Dimension *T* minus 0.06 in.

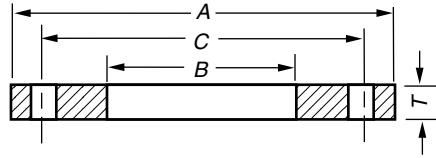

Table 5 AWWA standard steel-ring flanges, class E* (275 psi)

Nominal Pipe Size <i>in.</i>	OD of Flange (A) <i>in.</i>	ID of Flange (B [†]) <i>in.</i>	Number of Bolts	Diam. of Bolt Circle (C) <i>in.</i>	Diam. of Bolts [‡] <i>in.</i>	Thickness of Flange (T) <i>in.</i>
4	9.00	4.57	8	7.50	0.625	1.125
5	10.00	5.66	8	8.50	0.750	1.188
6	11.00	6.72	8	9.50	0.750	1.313
8	13.50	8.72	8	11.75	0.750	1.500
10	16.00	10.88	12	14.25	0.875	1.563
12	19.00	12.88	12	17.00	0.875	1.750
14	21.00	14.19	12	18.75	1.000	1.875
16	23.50	16.19	16	21.25	1.000	2.000
18	25.00	18.19	16	22.75	1.125	2.125
20	27.50	20.19	20	25.00	1.125	2.375
22	29.50	22.19	20	27.25	1.250	2.500
24	32.00	24.19	20	29.50	1.250	2.625
26	34.25		24	31.75	1.250	2.750
28	36.50		28	34.00	1.250	2.750
30	38.75		28	36.00	1.250	2.875
32	41.75		28	38.50	1.500	3.000
34	43.75		32	40.50	1.500	3.000
36	46.00		32	42.75	1.500	3.125
38	48.75		32	45.25	1.500	3.125
40	50.75		36	47.25	1.500	3.250
42	53.00		36	49.50	1.500	3.375
44	55.25		40	51.75	1.500	3.375
46	57.25		40	53.75	1.500	3.438
48	59.50		44	56.00	1.500	3.500
50	61.75		44	58.25	1.750	3.500
52	64.00		44	60.50	1.750	3.625

Notes:

1. Ring flanges may be overbored or counterbored to accommodate larger outside diameter pipe than shown as nominal. This is done to allow a clear inside diameter after cement–mortar lining. Wrench clearance between the pipe OD and bolt circle must be maintained as well as sufficient gasket seating area.

2. Metric conversion: nominal pipe size: $\text{in.} \times 25 = \text{mm}$; dimensions: $\text{in.} \times 25.4 = \text{mm}$; $\text{psi} \times 6.895 = \text{kPa}$.

*Pressure rating at atmospheric temperature is 275 psi. These flanges have the same diameter and drilling as ANSI B16.1, class 125 cast-iron flanges. In sizes 24 in. and smaller, they also match ANSI B16.5, 150 psi standard for steel flanges.

[†]The purchaser shall specify the ID of the flange, dimension B, for nominal pipe sizes 26 in. and larger. It is recommended that this dimension be $\frac{3}{16}$ in. larger in diameter than the nominal OD of the pipe.

[‡]Bolt holes shall be drilled $\frac{1}{8}$ in. larger in diameter than the nominal diameter of the bolt as stated in Sec. 4.2.3.

Table 5 AWWA standard steel-ring flanges, class E* (275 psi)–cont.

Nominal Pipe Size <i>in.</i>	OD of Flange (A) <i>in.</i>	ID of Flange (B [†]) <i>in.</i>	Number of Bolts	Diam. of Bolt Circle (C) <i>in.</i>	Diam. of Bolts [‡] <i>in.</i>	Thickness of Flange (T) <i>in.</i>
54	66.25		44	62.75	1.750	3.750
60	73.00		52	69.25	1.750	3.875
66	80.00		52	76.00	1.750	4.250
72	86.50		60	82.50	1.750	4.375
78	93.00		64	89.00	2.000	4.750
84	99.75		64	95.50	2.000	4.750
90	106.50		68	102.00	2.250	5.125
96	113.25		68	108.50	2.250	5.125
102	120.00		72	114.50	2.500	5.500
108	126.75		72	120.75	2.500	5.500
114	133.50		76	126.75	2.750	5.875
120	140.25		76	132.75	2.750	5.875
126	147.00		80	139.25	3.000	6.250
132	153.75		80	145.75	3.000	6.250
138	160.50		84	152.00	3.250	6.750
144	167.25		84	158.25	3.250	6.750

Notes:

1. Ring flanges may be overbored or counterbored to accommodate larger outside diameter pipe than shown as nominal. This is done to allow a clear inside diameter after cement–mortar lining. Wrench clearance between the pipe OD and bolt circle must be maintained as well as sufficient gasket seating area.

2. Metric conversion: nominal pipe size: $\text{in.} \times 25 = \text{mm}$; dimensions: $\text{in.} \times 25.4 = \text{mm}$; $\text{psi} \times 6.895 = \text{kPa}$.

*Pressure rating at atmospheric temperature is 275 psi. These flanges have the same diameter and drilling as ANSI B16.1, class 125 cast-iron flanges. In sizes 24 in. and smaller, they also match ANSI B16.5, 150 psi standard for steel flanges.

†The purchaser shall specify the ID of the flange, dimension B, for nominal pipe sizes 26 in. and larger. It is recommended that this dimension be $\frac{3}{16}$ in. larger in diameter than the nominal OD of the pipe.

‡Bolt holes shall be drilled $\frac{1}{8}$ in. larger in diameter than the nominal diameter of the bolt as stated in Sec. 4.2.3.

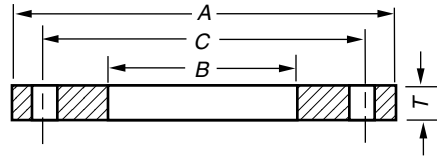

Table 6 AWWA standard steel-ring flanges, class F* (300 psi)

Nominal Pipe Size <i>in.</i>	OD of Flange (A) <i>in.</i>	ID of Flange (B) <i>in.</i>	Number of Bolts	Diam. of Bolt Circle (C) <i>in.</i>	Diam. of Bolts [†] <i>in.</i>	Thickness of Flange (T) <i>in.</i>
4	10.00	4.57	8	7.88	0.750	1.13
5	11.00	5.66	8	9.25	0.750	1.21
6	12.50	6.73	12	10.62	0.750	1.31
8	15.00	8.73	12	13.00	0.875	1.31
10	17.50	10.88	16	15.25	1.000	1.50
12	20.50	12.88	16	17.75	1.125	1.63
14	23.00	14.19	20	20.25	1.125	1.94
16	25.50	16.19	20	22.50	1.250	2.14
18	28.00	18.19	24	24.75	1.250	2.25
20	30.50	20.19	24	27.00	1.250	2.33
22	33.00	22.19	24	29.25	1.250	2.50
24	36.00	24.19	24	32.00	1.500	2.69
26	38.25	26.25	28	34.50	1.750	3.00
28	40.75	28.25	28	37.00	1.750	3.13
30	43.00	30.25	28	39.25	1.750	3.15
32	45.25	32.25	28	41.50	1.750	3.25
34	47.50	34.25	28	43.50	1.750	3.38
36	50.00	36.25	32	46.00	2.000	3.46
38	52.25	38.25	32	48.00	2.000	3.50
40	54.25	40.25	36	50.25	2.000	3.63
42	57.00	42.25	36	52.75	2.000	3.81
44	59.25	44.25	36	55.00	2.000	4.00
46	61.50	46.25	40	57.25	2.000	4.13
48	65.00	48.25	40	60.75	2.000	4.50

Notes:

1. Ring flanges may be overbored or counterbored to accommodate larger outside diameter pipe than shown as nominal. This is done to allow a clear inside diameter after cement mortar lining. Wrench clearance between the pipe OD and bolt circle must be maintained as well as sufficient gasket seating area.

2. Metric conversion: nominal pipe size: $\text{in.} \times 25 = \text{mm}$; dimensions: $\text{in.} \times 25.4 = \text{mm}$; $\text{psi} \times 6.895 = \text{kPa}$.

*Pressure rating at atmospheric temperature is 300 psi. These flanges have the same diameter and drilling as ANSI B16.2, class 250 cast iron pipe and flanged fittings.

†Bolt holes shall be drilled $\frac{1}{8}$ in. larger in diameter than the nominal diameter of the bolt as stated in Sec. 4.2.3.

Table 7 AWWA blind-flange thickness

Nominal Pipe Size		Minimum Thickness*									
		Mating Flange ID		Class B 86 psi (593 kPa)		Class D [†]		Class E 275 psi (1,896 kPa)		Class F 300 psi (2,068 kPa)	
<i>in.</i>	<i>(mm)</i>	<i>in.</i>	<i>(mm)</i>	<i>in.</i>	<i>(mm)</i>	<i>in.</i>	<i>(mm)</i>	<i>in.</i>	<i>(mm)</i>	<i>in.</i>	<i>(mm)</i>
4	(100)	4.57	(116)	0.625	(15.88)	0.625	(15.88)	1.125	(28.58)	1.130	(28.70)
5	(125)	5.66	(1.44)	0.625	(15.88)	0.650	(16.51)	1.188	(30.18)	1.210	(30.73)
6	(150)	6.72	(171)	0.688	(17.48)	0.693	(17.59)	1.313	(33.35)	1.310	(33.27)
8	(200)	8.72	(221)	0.688	(17.48)	0.812	(20.62)	1.500	(38.10)	1.310	(33.27)
10	(250)	10.88	(276)	0.688	(17.48)	0.953	(24.21)	1.563	(39.70)	1.500	(38.10)
12	(300)	12.88	(327)	0.719	(18.26)	1.117	(28.37)	1.750	(44.45)	1.630	(41.40)
14	(350)	14.19	(360)	0.791	(20.10)	1.133	(28.78)	1.875	(47.63)	1.940	(49.28)
16	(400)	16.19	(411)	0.892	(22.66)	1.265	(32.13)	2.000	(50.80)	2.140	(54.36)
18	(450)	18.19	(462)	0.950	(24.13)	1.331	(33.81)	2.125	(53.98)	2.250	(57.15)
20	(500)	20.19	(513)	1.040	(26.42)	1.448	(36.77)	2.375	(60.33)	2.330	(59.18)
22	(550)	22.19	(564)	1.132	(28.74)	1.568	(39.83)	2.500	(63.50)	2.500	(63.50)
24	(600)	25.50	(648)	1.216	(30.89)	1.661	(42.18)	2.625	(66.68)	2.690	(68.53)
26	(650)	27.50	(699)	1.307	(33.20)	1.786	(45.37)	2.750	(69.85)	3.000	(76.20)
28	(700)	29.50	(749)	1.398	(35.50)	1.906	(48.40)	2.750	(69.85)	3.130	(79.50)
30	(750)	31.50	(800)	1.477	(37.53)	2.008	(51.00)	2.875	(73.03)	3.166	(80.42)
32	(800)	33.50	(851)	1.581	(40.16)	2.150	(54.60)	3.000	(76.20)	3.332	(84.62)
34	(850)	35.50	(902)	1.661	(42.19)	2.252	(57.21)	3.050	(77.46)	3.475	(88.25)
36	(900)	37.63	(956)	1.751	(44.48)	2.370	(60.20)	3.209	(81.51)	3.671	(93.25)
38	(950)	39.63	(1,006)	1.853	(47.06)	2.506	(63.66)	3.394	(86.20)	3.815	(96.90)
40	(1,000)	41.63	(1,057)	1.933	(49.09)	2.609	(66.28)	3.533	(89.74)	3.982	(101.40)
42	(1,050)	43.63	(1,108)	2.023	(51.40)	2.729	(69.32)	3.695	(93.86)	4.171	(105.92)
44	(1,100)	45.63	(1,159)	2.114	(53.70)	2.849	(72.36)	3.857	(97.97)	4.338	(110.19)
46	(1,150)	47.63	(1,210)	2.194	(55.73)	2.952	(74.99)	3.997	(101.53)	4.505	(114.43)
48	(1,200)	49.63	(1,260)	2.285	(58.03)	3.072	(78.03)	4.159	(105.65)	4.781	(121.44)
50	(1,250)	51.75	(1,314)	2.377	(60.38)	3.196	(81.17)	4.327	(109.90)		
52	(1,300)	53.75	(1,365)	2.468	(62.69)	3.315	(84.21)	4.489	(114.02)		
54	(1,350)	55.75	(1,416)	2.559	(64.99)	3.435	(87.25)	4.651	(118.14)		
60	(1,500)	61.75	(1,568)	2.820	(71.63)	3.779	(95.97)	5.116	(129.95)		
66	(1,650)	67.88	(1,724)	3.092	(78.53)	4.136	(105.06)	5.601	(142.26)		
72	(1,800)	73.88	(1,876)	3.353	(85.17)	4.480	(113.80)	6.066	(154.08)		

Notes:

1. All flanges are flat faced.
2. ASTM A-36 steel used (allowable stress 16,000 psi).
3. ASTM A-307 Grade B bolts (7,000 psi allowable stress) used for class B and D.
4. ASTM A193 Grade B7 bolts (25,000 psi allowable stress) used for class E and F.
5. For diameters over 48 in., designers should consider using dished heads welded to a standard flange.

*Design Method: ASME Boiler & Pressure Vessel Code, Sec. VIII, Div. 1.

†Class D flanges are rated at 175 psi (1,207 kPa) for nominal pipe sizes ≤12 in. (600 mm), and 150 psi (1,034 kPa) for nominal pipe sizes > 12 in. (600 mm).

APPENDIX A

Bibliography

This appendix is for information only and is not a part of AWWA C207.

Steel Ring Flanges for Steel Pipe. ARMCO Bulletin 47A (1947).

ASME Unfired Pressure Vessel Code. Divisions I and II (1974).

Discussion of Formulas for Stresses in Bolted Flanged Connections. *Trans. ASME*, 60:267 (Apr. 1938).

Flange Design. Bureau of Reclamation Memorandum (July 15, 1947).

Hill, H.O.; Lewis, W.W.; & Easter, H.O. Fabricated Steel Ring Flanges for Water Pipe Service for Low Pressures and Low Temperatures. *Jour. AWWA* 36:9:968 (Sept. 1944).

Modern Flange Design. Taylor Forge and Pipe Works (2nd ed., 1941).

Timoshenko, S. *Strength of Materials, Part II.* D. Van Nostrand Co., Inc., New York, N.Y. (4th ed., 1962).

Timoshenko, S. *Theory of Plates and Shells.* McGraw-Hill Book Co., New York, N.Y. (2nd ed., 1959).

Waters, E.O. et al. Formulas for stresses in Bolted Flanged Connections. *Trans. ASME*, 59:161 (1937).

Waters, E.O. & Taylor, J.H. The Strength of Pipe Flanges. *Mechanical Engineering*, 49:5:531 (May 1927).

ADOPTION NOTICE

AWWA-C207, "Steel Pipe Flanges for Waterworks Service - Sizes 4 inches through 144 inches," was adopted on 27-JAN-87 for use by the Department of Defense (DoD). Proposed changes by DoD activities must be submitted to the DoD Adopting Activity: Defense Supply Center Columbus, P.O. Box 3990, Attn: DCSC-VAT, Columbus, OH 43216-5000. DoD activities may obtain copies of this standard from the Standardization Document Order Desk, 700 Robbins Avenue, Building 4D, Philadelphia, PA 19111-5094. The private sector and other Government agencies may purchase copies from the American Water Works Association, 6666 West Quincy Avenue, Denver, CO 80235.

